



128GB

K755 128GB SATA3 Solid State Drive Datasheet

(Based on NAND Flash)

Version: 1.0

Kston Memory Technolitics Co.,Ltd

Add:4/F,Office Bld, YaLiTong Industrial,162 Luyuan Rd,TangXia,DongGuan,China



NOTE:Kston Memory Technolitics Co.,Ltd

Add:4/F,Office Bld, YaLiTong Industrial,162 Luyuan Rd,TangXia,DongGuan,China

Kston Memory Technolitics Co.,Ltd

Add:4/F,Office Bld, YaLiTong Industrial,162 Luyuan Rd,TangXia,DongGuan,China



Table of Contents

Kston INDUSTRIAL LIMITED	
128GB	1
k755 128GB SATA3 Solid State Drive Datasheet	1
I. Introduction	4
1 Overview	4
2 Part Type Introduction	4
Outline	5
II. Block Diagram	6
IV. Product Specifications	7
4.1 Physical Dimensions	7
4.2 Interface Specification	8
4.2.1 Pin Assignment	8
4.2.2 Interface Mode	9
V. Reliability	9
5.1 ECC Descriptions	9
5.2 Advance Wear-Leveling Algorithm	9
5.3 S.M.A.R.T Function	9
VI. Ordering Information	10
VII. Related documentation	10
Attachment	10

Kston Memory Technolitics Co.,Ltd

Add:4/F,Office Bld, YaLiTong Industrial,162 Luyuan Rd,TangXia,DongGuan,China



I. Introduction

1 Overview

1 Overview

Kston SATA SSD (Solid State Drive) is a high performance and high reliability storage device based on NAND Flash technology that designed to solve the bottleneck of computing system by traditional hard disk drives. Our SATA SSD doesn't have a moving parts and it has a same host interface and same physical dimension with Hard Disk Drive, so it can be drop-in replaced with the hard disk drives without anything. With a high performance and low power consumption, Our SATA SSD can be a good storage device for NB and Tabletop PC.

Kstn SATA SSD purely consists of semiconductor devices and NAND flash memories, which give rugged features against shock and vibration, used in extreme environment such as industrial PC to increase MTBF. Furthermore, Our SATA SSD has highly advanced flash memory management algorithm to guarantee

2 Part Type Introduction

This chapter is about the specifications of the 2.5" SATA Solid State Drive SSD with SATA III interface.

Type	Capacity	Flash	Interface
K755	128GB	3D TLC	SATA III

Table 1 Capacity Specifications

Capacity	Available Capacity	R / W(MB/s)	Random R/W	IOPS
128GB	119.24GB	500/380MB/S	32586/74023	

Kston Memory Technologies Co.,Ltd

Add:4/F,Office Bld, YaLiTong Industrial,162 Luyuan Rd,TangXia,DongGuan,China



Outline

Based spec	Interface	SATAIII
	Dimension	100*70*7 mm
	Weight ①	42~45g
	Capacity	128GB
	Controller	RM1135
	Flash type	3D TLC NAND Flash
Read/Write Performance ②	CDM Sequential Read	Up to 500MB/s
	CDM Sequential Write	Up to 450MB/s
	ATTO Sequential Read	Up to 500MB/s
	ATTO Sequential Write	Up to 450MB/s
Power Consumption	Power Supply	5V±5%
	Standby	0.3W
	Maximum Ripple	70 mV(peak to peak)
	4KB Random Write	2.5W
Reliability	Write endurance:3years @ 100G write/day	
	Read endurance: unlimited	
	MTBF: >2,000,000 hours	
	Data retention: >20years @ 25°C	
	Data destroy do not support	
	Sudden power-off recovery support	
	S.M.A.R.T,NCQ,Trim and dynamic power management support	
	Static and dynamic wear-leveling	
	Bad block management algorithm	
	ECC: LDPC ECC	
Environment	Storage temperature: -55~95 °C	
	Operation temperature: 0~75°C	
	Humidity: 5%~95%	
	Vibration	15G (10 to 2000Hz)
	Shock	350G at 0.5ms
Warranty	3 years	

Table 2 outline of the driver

①, ②: The Read/Write performance and weight vary with different capacity of products.
The testing environment is below:

Kston Memory Technologic Co.,Ltd

Add:4/F,Office Bld, YaLiTong Industrial,162 Luyuan Rd,TangXia,DongGuan,China

OS: Windows 7 Ultimate
CPU: Intel (R) Core(TM) i3-2100T CPU @2.50GHz
Memory: 4GB
Motherboard: Controller:RM1135,SATA III,128GB SSD
Test program: ATTO Disk BenchMark ; CrystalDiskMark
Test Drive: k755 128GB (3D TLC)

II.Block Diagram

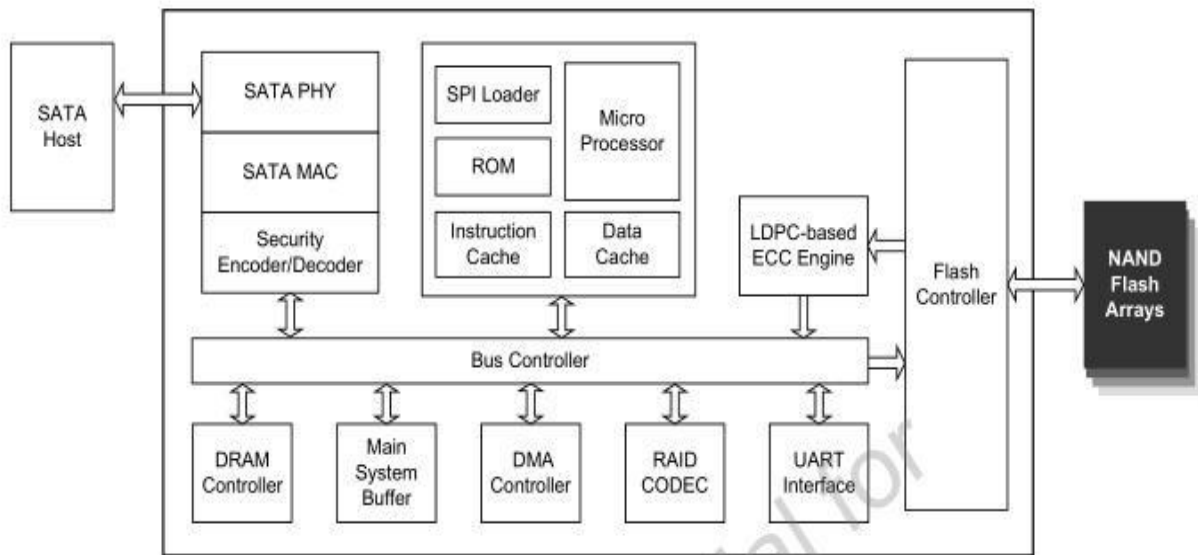

Figure 1 RM1135 Block Diagram

IV. Product Specifications

4.1 Physical Dimensions

Parameter	Value
Length	100±0.1 mm
width	70±0.1 mm
height	7±0.1 mm

Table 3 Physical dimensions of the driver

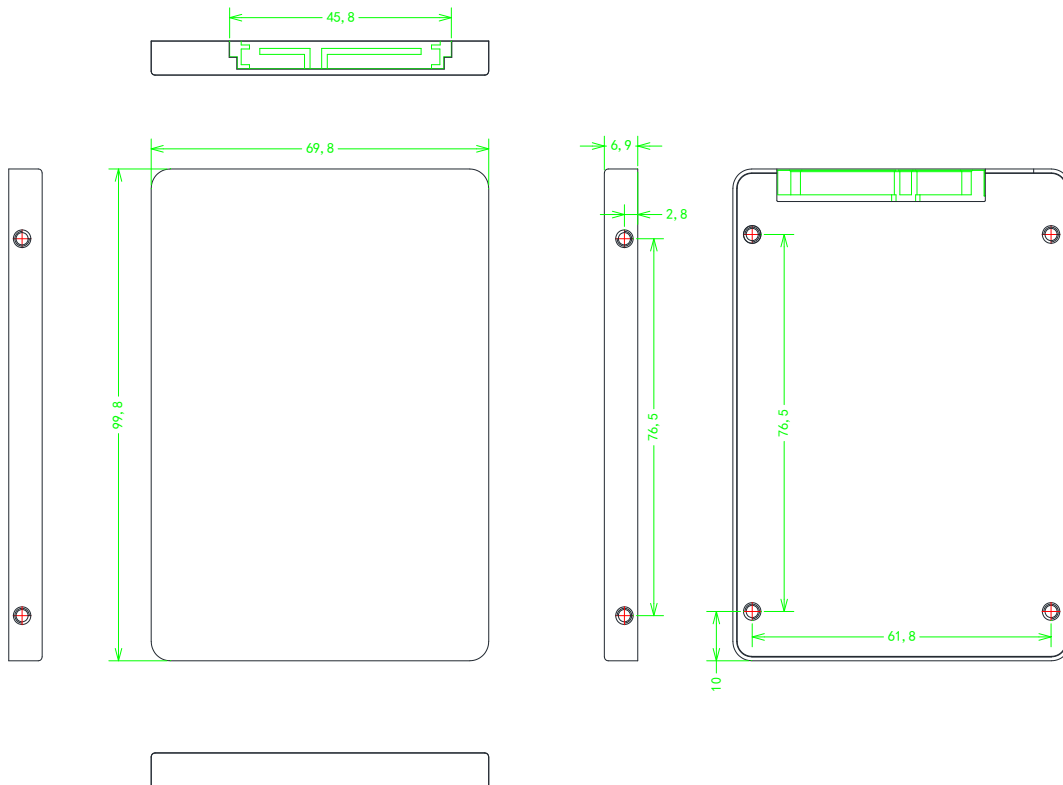

Figure 2 Physical dimensions

Kston Memory Technologics Co.,Ltd

Add:4/F,Office Bld, YaLiTong Industrial,162 Luyuan Rd,TangXia,DongGuan,China

4.2 Interface Specification

4.2.1 Pin Assignment

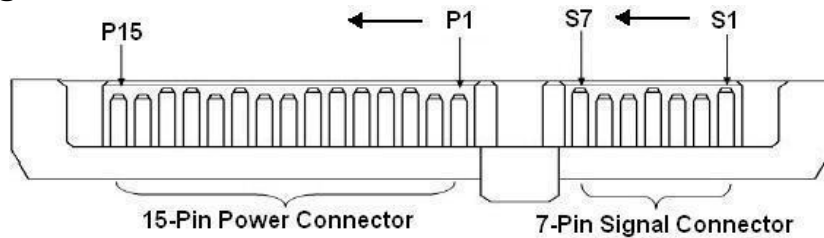

Figure 3 Pin connector

Pin number	Signal name	Description
S1	GND	2 nd mate
S2	A+	Differential signal pair A From physical layer electronics
S3	A-	
S4	GND	2 nd mate
S5	B-	Differential signal pair B From physical layer electronics
S6	B+	
S7	GND	2 nd mate
P1	V33	3.3V power (unused)
P2	V33	3.3V power (unused)
P3	V33	3.3V power,pre-charge,2 nd mate(unused)
P4	GND	1 st mate
P5	GND	2 nd mate
P6	GND	2 nd mate
P7	V5	5V power,pre-charge,2 nd mate
P8	V5	5V power
P9	V5	5V power
P10	GND	2 nd mate
P11	DAS/DSS	Device activity signal/Disable staggered spinal(unused)
P12	GND	1 st mate

Kston Memory Technologics Co.,Ltd

Add:4/F,Office Bld, YaLiTong Industrial,162 Luyuan Rd,TangXia,DongGuan,China

P13	V12	12V power,pre-charge,2 nd mate(unused)
P14	V12	12V power(unused)
P15	V12	12V power(unused)

Table 4SATAIII interface pin assignment

4.2.2 Interface Mode

The interface of the 2.5" SATA SSD complies with the standard Serial ATA version 3.1:

- ①Host Transfer Rate is 600MB/s(6.0Gb/s)
- ②PIO mode 0,1,2,3,4
- ③DMA mode 0,1,2
- ④UDMA mode 0,1,2,3,4,5,6

V. Reliability

5.1 ECC Descriptions

The LDPC ECC engine executes parity generation and error detection/correction features, and enhances decoding throughput and data reliability. With LDPC of correction capacity 1e-2 RBER, the hard and soft decoding mechanism provides powerful error correction. Hence the RM1135 can enhance the endurance and retention of 3D TLC Nand Flash and extends the SSD lifespan.

5.2 Advance Wear-Leveling Algorithm

The NAND flash devices are limited by a certain number of write cycles. When using a file system, frequent file table updates is mandatory. If some area on the flash wears out faster than others, it would significantly reduce the lifetime of the whole device, even if the erase counts of others are far from the write cycle limit. Thus, if the write cycles can be distributed evenly across the media, the lifetime of the media can be prolonged significantly. The scheme is achieved both via buffer management and specific advanced wear leveling to ensure that the lifetime of the flash media can be increased, and the disk access performance is optimized as well.

5.3 S.M.A.R.T Function

S.M.A.R.T. is an acronym for Self-Monitoring, Analysis and Reporting Technology, an open standard allowing disk drives to automatically monitor their own health and report potential problems. It protects the user from unscheduled downtime by monitoring and storing critical drive performance and calibration parameters. Ideally, this should allow taking proactive actions to prevent impending drive failure. SMART feature adopts the standard SMART command B0h to read data from the drive. When the SMART Utility running on the host, it analyzes and reports the disk status to the host before the device is in critical condition.

Kston Memory Technologies Co.,Ltd

Add:4/F,Office Bld, YaLiTong Industrial,162 Luyuan Rd,TangXia,DongGuan,China



VI. Ordering Information

Model	Capacity	PN
K755	128GB	K755-128GB

VII. Related documentation

For more information, Pls contact me : linda@arayworld.com

Attachment

Test platform:

System : Windows 10

CPU: Intel (R) Core(TM) CPU G3930@2.90GHz

Memory : 4GB

Mother Board: Controller:RM1135,SATA III,128GB

Test SSD:Controller:SMI2258XT,SATA III,K755 - 128GB

Kston Memory Technolitics Co.,Ltd

Add:4/F,Office Bld, YaLiTong Industrial,162 Luyuan Rd,TangXia,DongGuan,China

Test performance picture:

ATTO Disk Benchmark

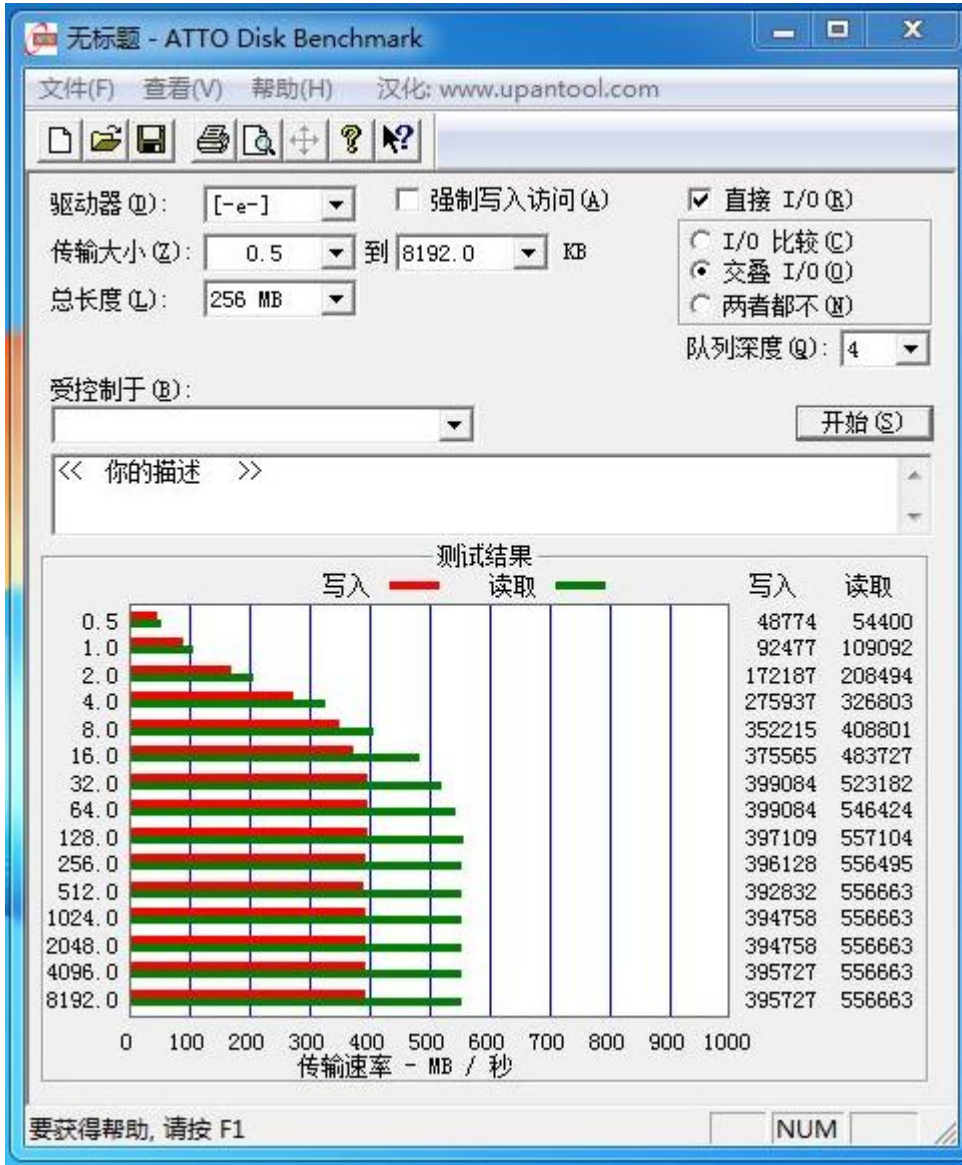

Kston Memory Technologics Co.,Ltd

Add:4/F,Office Bld, YaLiTong Industrial,162 Luyuan Rd,TangXia,DongGuan,China



AS SSD benchmark

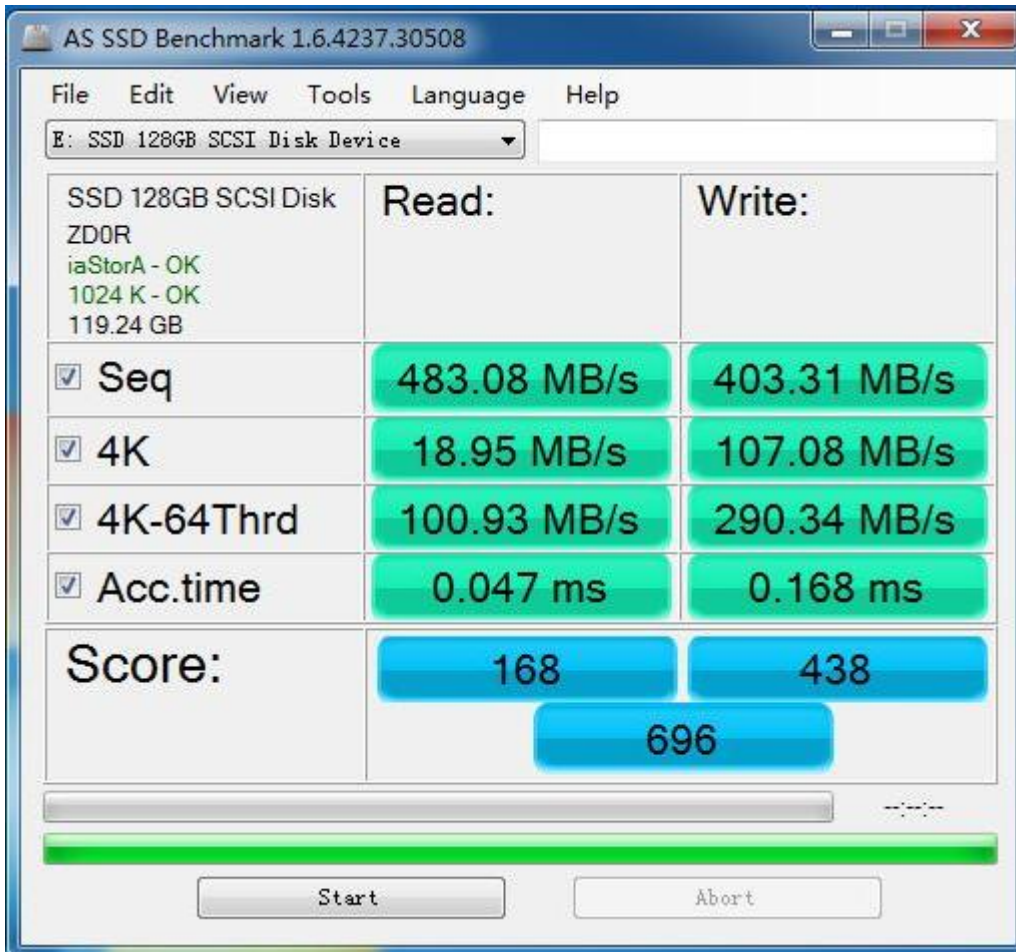

Kston Memory Technolitics Co.,Ltd

Add:4/F,Office Bld, YaLiTong Industrial,162 Luyuan Rd,TangXia,DongGuan,China

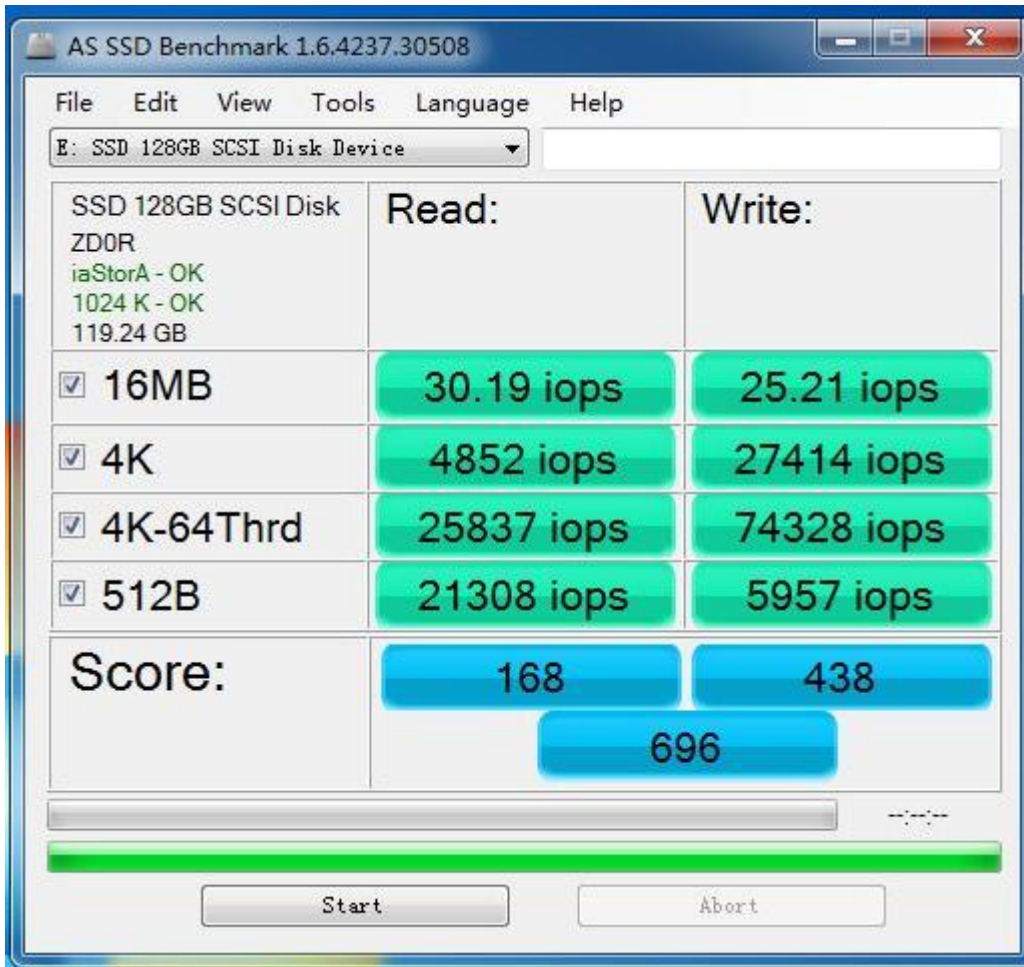

Crystal Disk Mark

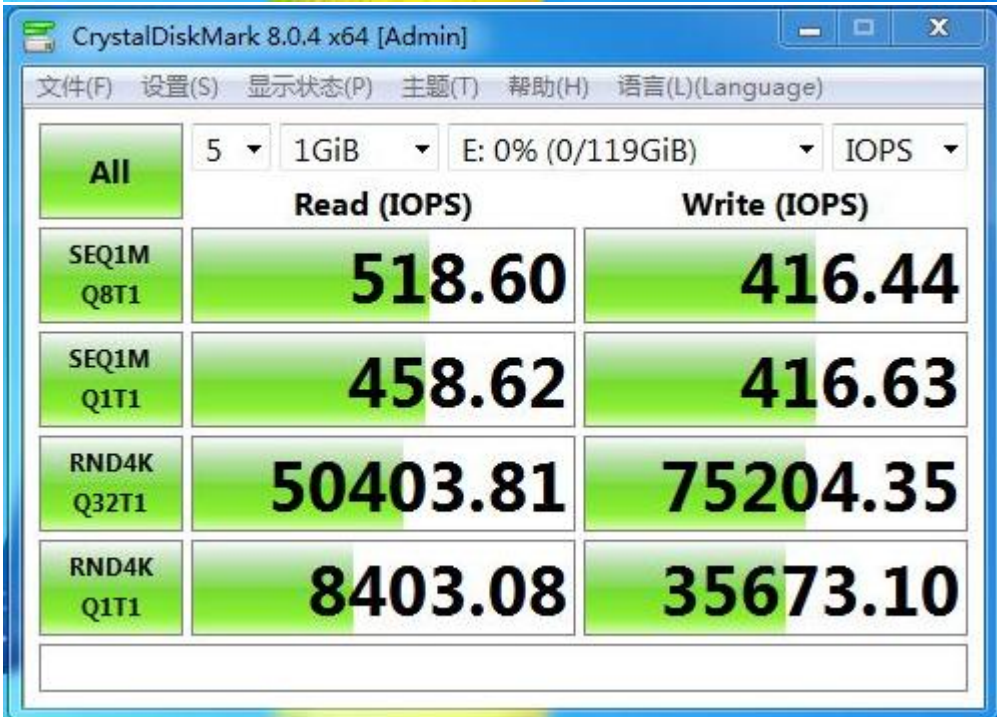

Kston Memory Technolitics Co.,Ltd

Add:4/F,Office Bld, YaLiTong Industrial,162 Luyuan Rd,TangXia,DongGuan,China